

*Present in over 50 countries*

**2014**



*We produce batteries since 1925*

**ISO 9001 ISO 14001 ISO/TS 16949**

*We produce batteries since 1925*



*Present in over 50 countries*

*Silver*



[www.sznajder.eu](http://www.sznajder.eu)

*Silver Premium*

*Expedition plus AGM*

*Silver Japan*

*Plus Japan cars*

*Plus*

*Plus Ford*

*Energy Plus*

*Truck PLUS  
Evolution*

*Truck SHD*

*Marine*

*Farme*



Catalogue code	Ah 20h	A EN								Magic Eye	Fire Protection	
<b>Silver Premium</b>												
562 36	62	620	1	1	B13	L2	SL/IV	IHL	X	X		
<b>Silver Premium</b>												
564 45	64	600	0	1	B13+A	LB2	SL/IV	IHL	X	X		
<b>Silver Premium</b>												
565 35	65	620	0	1	B13	L2	SL/IV	IHL	X	X		
<b>Silver Premium</b>												
565 36	65	620	1	1	B13	L2	SL/IV	IHL	X	X		
<b>Silver Premium</b>												
575 45	75	750	0	1	B13+A	LB3	SL/IV	IHL	X	X		
<b>Silver Premium</b>												
580 35	80	760	0	1	B13	L3	SL/IV	IHL	X	X		
<b>Silver Premium</b>												
585 45	85	800	0	1	B13+A	LB4	SL/IV	IHL	X	X		
<b>Silver Premium</b>												
600 35	100	900	0	1	B13	L5	SL/IV	IHL	X	X		

# Silver / Silver Japan

Catalogue code	Ah 20h	A EN								Magic Eye	Fire Protection
----------------	--------	------	--	--	--	--	--	--	--	-----------	-----------------

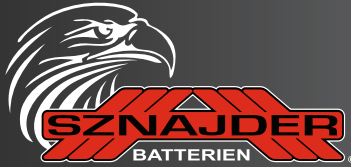
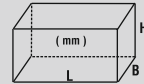

THE POWER COMPANY-SINCE 1925

## Silver Japan

535 70	35	280	0	3	B00	B20	BL/IV	HL1	X	X
--------	----	-----	---	---	-----	-----	-------	-----	---	---

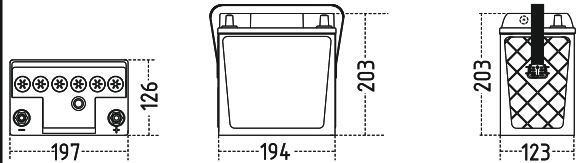

## Silver Japan

535 72	35	280	1	3	B00	B20	BL/IV	HL1	X	X
--------	----	-----	---	---	-----	-----	-------	-----	---	---

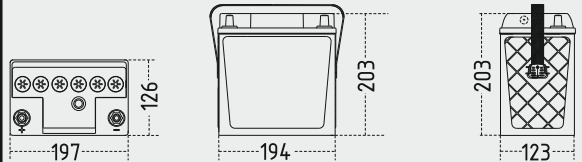

## Silver Japan

545 70	45	360	0	3+A	B00	B24	BL/IV	IHL	X	X
--------	----	-----	---	-----	-----	-----	-------	-----	---	---

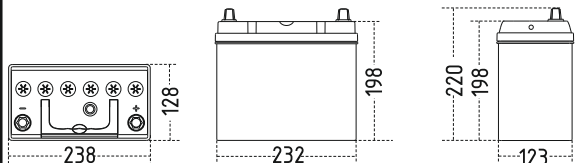

## Silver Japan

545 72	45	360	1	3+A	B00	B24	BL/IV	IHL	X	X
--------	----	-----	---	-----	-----	-----	-------	-----	---	---

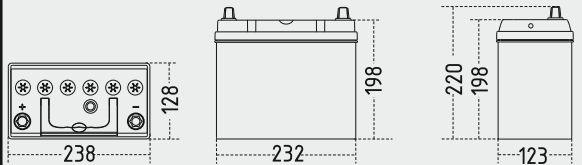

## Silver

546 25	46	400	0	1	B13+A	LB1	SL/IV	IHL	X	X
--------	----	-----	---	---	-------	-----	-------	-----	---	---

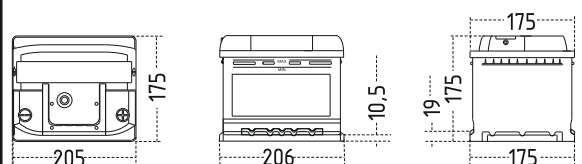

## Silver

553 25	53	450	0	1	B13+A	LB1	SL/IV	IHL	X	X
--------	----	-----	---	---	-------	-----	-------	-----	---	---



## Silver

555 25	55	460	0	1	B13	L1	SL/IV	IHL	X	X
--------	----	-----	---	---	-----	----	-------	-----	---	---

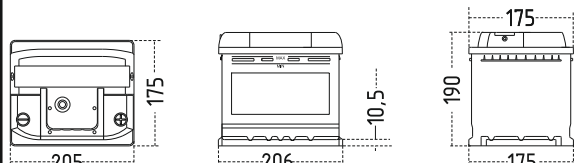

## Silver

555 26	55	460	1	1	B13	L1	SL/IV	IHL	X	X
--------	----	-----	---	---	-----	----	-------	-----	---	---

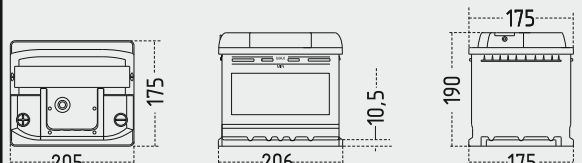

Catalogue code	Ah 20h	A EN								Mag. Eye	Fire Protection	
<b>Silver</b>												
562 25	62	540	0	1	B13	L2	SL/IV	IHL	X	X		
<b>Silver</b>												
564 25	64	530	0	1	B13+A	LB2	SL/IV	IHL	X	X		
<b>Silver</b>												
565 25	65	540	0	1	B13	L2	SL/IV	IHL	X	X		
<b>Silver</b>												
565 26	65	540	1	1	B13	L2	SL/IV	IHL	X	X		
<b>Silver</b>												
570 25	70	570	0	1	B13	L2	SL/IV	IHL	X	X		
<b>Silver</b>												
570 26	70	570	1	1	B13	L2	SL/IV	IHL	X	X		
<b>Silver</b>												
575 25	75	640	0	1	B13+A	LB3	SL/IV	IHL	X	X		
<b>Silver</b>												
580 28	80	700	0	1	B13+A	LB4	SL/IV	IHL	-	-		
<b>Silver</b>												
580 25	80	700	0	1	B13	L3	SL/IV	IHL	X	X		
<b>Silver Japan</b>												
580 70	80	560	0	1	B05	D26	BL/IV	IHL	X	X		

Catalogue code	Ah 20h	A EN								MagiC Eye	Fire Protection	
<b>Silver Japan</b>												
580 72	80	560	1	1	B05	D26	BL/IV	IHL	X	X		
<b>Silver</b>												
585 25	85	700	0	1	B13	L4	SL/IV	IHL	-	-		
<b>Silver</b>												
596 25	96	760	0	1	B13+A	LB5	SL/IV	IHL	X	X		
<b>Silver</b>												
600 25	100	800	0	1	B13	L5	SL/IV	IHL	X	X		
<b>Silver Japan</b>												
600 70	100	700	0	1	B01	D31	BL/IV	IHL	X	X		
<b>Silver Japan</b>												
600 72	100	700	1	1	B01	D31	BL/IV	IHL	X	X		



# Plus / Plus Japan cars / Plus Ford

Catalogue code

Ah 20h

A EN



Magic Eye

Fire Protection

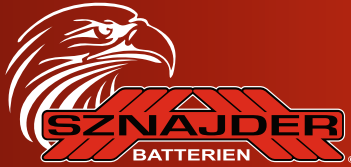
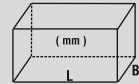

## THE POWER COMPANY-SINCE 1925

### Plus Japan cars

535 77	35	270	0	1	B01	E1	FL	HL1	-	X
--------	----	-----	---	---	-----	----	----	-----	---	---

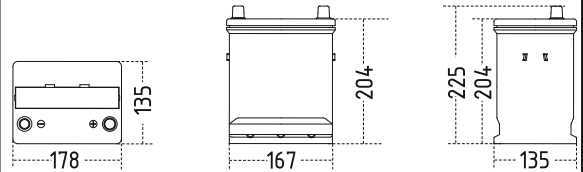

### Plus

538 46	38	300	1	1	B13	L1	SL/IV	IHL	-	X
--------	----	-----	---	---	-----	----	-------	-----	---	---

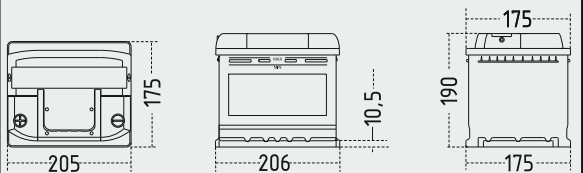

### Plus

538 58	38	300	0	1	B13+A	LB1	SL/IV	IHL	-	X
--------	----	-----	---	---	-------	-----	-------	-----	---	---

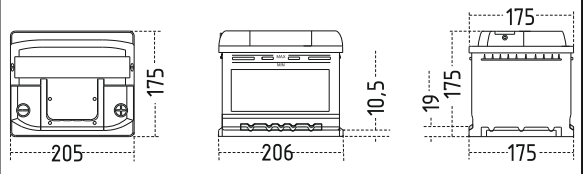

### Plus

538 59	38	300	0	1	B13	L1	SL/IV	IHL	-	X
--------	----	-----	---	---	-----	----	-------	-----	---	---

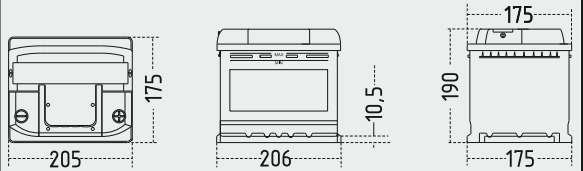

### Plus

543 08	43	340	0	1	B03	L0	SL	HL1	-	-
--------	----	-----	---	---	-----	----	----	-----	---	---

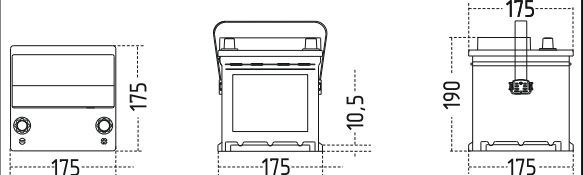

### Plus Japan cars

545 23	45	340	0	3+A	B00	B24	BL/IV	IHL	-	X
--------	----	-----	---	-----	-----	-----	-------	-----	---	---

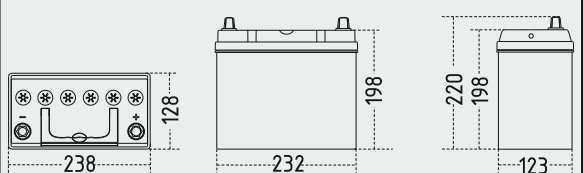

### Plus Japan cars

545 24	45	340	1	3+A	B00	B24	BL/IV	IHL	-	X
--------	----	-----	---	-----	-----	-----	-------	-----	---	---

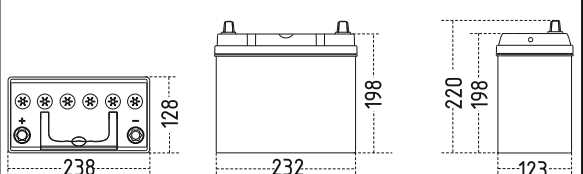

### Plus

545 58	45	370	0	1	B13+A	LB1	SL/IV	IHL	-	X
--------	----	-----	---	---	-------	-----	-------	-----	---	---

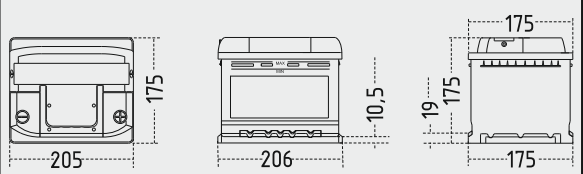

Catalogue code	Ah 20h	A EN								MagiC Eye	Fire Protection	
<b>Plus</b>												
545 59	45	360	0	1	B13	L1	SL/IV	IHL	-	X		
<b>Plus</b>												
545 65	45	360	1	1	B13	L1	SL/IV	IHL	-	X		
<b>Plus Japan cars</b>												
545 77	45	360	0	1	B01	E2	FL	HL1	-	X		
<b>Plus Japan cars</b>												
545 79	45	360	1	1	B01	E2	FL	HL1	-	X		
<b>Plus Ford</b>												
550 57	50	500	0	19	B13	LB1	SL/IV	IHL	-	-		
<b>Plus</b>												
550 58	50	420	0	1	B13+A	LB1	SL/IV	IHL	-	X		
<b>Plus</b>												
550 59	50	420	0	1	B13	L1	SL/IV	IHL	-	X		
<b>Plus</b>												
550 65	50	420	1	1	B13	L1	SL/IV	IHL	-	X		
<b>Plus</b>												
555 59	55	460	0	1	B13	L2	SL/IV	IHL	-	X		
<b>Plus</b>												
555 65	55	460	1	1	B13	L2	SL/IV	IHL	-	X		

Catalogue code	Ah 20h	A EN								Mag. Eye	Fire Protection	
<b>Plus Japan cars</b>												
560 48	60	360	0	1	B05	D26	BL/IV	IHL	-	X		
<b>Plus Japan cars</b>												
560 49	60	360	1	1	B05	D26	BL/IV	IHL	-	X		
<b>Plus</b>												
560 59	60	520	0	1	B13	L2	SL/IV	IHL	-	X		
<b>Plus Japan cars</b>												
560 68	60	460	0	1	B00	D23	FL	-	-	-		
<b>Plus Japan cars</b>												
560 68*	60	460	0	1	B00	D23	BL/IV	IHL	-	-		
<b>Plus</b>												
560 65	60	520	1	1	B13	L2	SL/IV	IHL	-	X		
<b>Plus Japan cars</b>												
560 69	60	460	1	1	B00	D23	FL	-	-	-		
<b>Plus Japan cars</b>												
560 69*	60	460	1	1	B00	D23	BL/IV	IHL	-	-		
<b>Plus</b>												
560 77	60	520	0	1	B13+A	LB2	SL/IV	IHL	-	X		
<b>Plus Ford</b>												
560 91	60	520	0	19	B13	LB2	SL/IV	IHL	-	-		

\* type available from 4th quarter of 2014

Catalogue code	Ah 20h	A EN								MagiC Eye	Fire Protection	
<b>Plus</b>												
562 58	62	520	0	1	B13+A	LB2	SL/IV	IHL	-	X		
<b>Plus</b>												
562 59	62	520	0	1	B13	L2	SL/IV	IHL	-	X		
<b>Plus</b>												
562 65	62	520	1	1	B13	L2	SL/IV	IHL	-	X		
<b>Plus</b>												
565 30	65	640	0	1	B13+A	LB3	SL/IV	IHL	-	X		
<b>Plus Japan cars</b>												
570 24	70	540	1	1	B05	D26	BL/IV	IHL	-	X		
<b>Plus Japan cars</b>												
570 29	70	540	0	1	B05	D26	BL/IV	IHL	-	X		
<b>Plus</b>												
570 38	70	600	0	1	B13	L3	SL/IV	IHL	-	X		
<b>Plus</b>												
570 58	70	610	0	1	B13+A	LB3	SL/IV	IHL	-	X		
<b>Plus Ford</b>												
572 21	72	640	0	19	B13	LB3	SL/IV	IHL	-	-		
<b>Plus</b>												
572 58	72	640	0	1	B13+A	LB3	SL/IV	IHL	-	X		

Catalogue code	Ah 20h	A EN								MagiC Eye	Fire Protection	
<b>Plus</b>												
574 12	74	680	0	1	B13	L3	SL/IV	IHL	-	X		
<b>Plus</b>												
574 14	74	680	1	1	B13	L3	SL/IV	IHL	-	X		
<b>Plus</b>												
575 19	75	720	1	1	B13	L3	SL/IV	IHL	-	X		
<b>Plus</b>												
575 20	75	720	0	1	B13	L3	SL/IV	IHL	-	X		
<b>Plus</b>												
588 27	88	640	0	1	B13	L5	SL/IV	IHL	-	X		
<b>Plus</b>												
592 18	92	720	0	1	B13	L5	SL/IV	IHL	-	X		
<b>Plus</b>												
592 21	92	720	1	1	B13	L5	SL/IV	IHL	-	X		
<b>Plus Japan cars</b>												
600 32	100	680	0	1	B01	D31	BL/IV	IHL	-	X		
<b>Plus Japan cars</b>												
600 33	100	680	1	1	B01	D31	BL/IV	IHL	-	X		
<b>Plus</b>												
600 38	100	760	0	1	B13	L5	SL/IV	IHL	-	X		

Catalogue code	Ah 20h	A EN								Magic Eye	Fire Protection	
<b>Plus</b>												
600 65	100	760	1	1	B13	L5	SL/IV	IHL	-	X		

## Truck PLUS Evolution / Truck SHD

Catalogue code	Ah 20h	A EN								Heavy Duty	Super Heavy Duty	
----------------	--------	------	--	--	--	--	--	--	--	------------	------------------	--

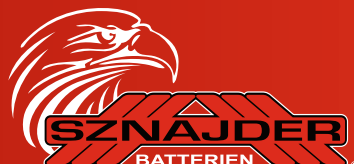

THE POWER COMPANY-SINCE 1925

### Truck PLUS

600 11	100	650	0	1	B01	D2	FL	IHL	-	-		
--------	-----	-----	---	---	-----	----	----	-----	---	---	--	--

### Truck PLUS Evolution

610 11	110	680	0	1	B01	D2	SL/IV	IHL	X	-		
--------	-----	-----	---	---	-----	----	-------	-----	---	---	--	--

### Truck PLUS Evolution

610 40	110	750	3	1	B03	MAC	SL/IV	HL2	X	-		
--------	-----	-----	---	---	-----	-----	-------	-----	---	---	--	--

### Truck PLUS Evolution

625 11	125	750	0	1	B01	D2	SL/IV	IHL	X	-		
--------	-----	-----	---	---	-----	----	-------	-----	---	---	--	--

### Truck PLUS Evolution

625 12	125	750	1	1	B01	D2	SL/IV	IHL	X	-		
--------	-----	-----	---	---	-----	----	-------	-----	---	---	--	--

### Truck PLUS Evolution

625 13	125	690	3	1	B00	D4	FL	HL2	X	-		
--------	-----	-----	---	---	-----	----	----	-----	---	---	--	--

### Truck PLUS Evolution

625 27	125	690	4	1	B03	D4	FL	HL2	X	-		
--------	-----	-----	---	---	-----	----	----	-----	---	---	--	--



Catalogue code	Ah 20h	A EN								Heavy Duty	Super Heavy Duty	
<b>Truck SHD</b>												
650 32	150	850	3	1	B00	D4	FL	HL2	-	X		
<b>Truck PLUS Evolution</b>												
670 18	170	950	3	1	B00	D5	SL/IV	HL2	X	-		
<b>Truck PLUS Evolution</b>												
670 19	170	950	3	1	B00	D5	FL	HL2	X	-		
<b>Truck PLUS Evolution</b>												
680 13	180	1000	3	1	B00	D5	SL/IV	HL2	X	-		
<b>Truck PLUS Evolution</b>												
680 14	180	1000	3	1	B00	D5	FL	HL2	X			
<b>Truck SHD</b>												
680 32	180	1000	3	1	B00	D5	SL/IV	HL2	-	X		
<b>Truck PLUS Evolution</b>												
680 33	180	1000	3	1	B03	D5	SL/IV	HL2	X	-		
<b>Truck SHD</b>												
680 34	180	1000	3	1	B00	D5	FL	HL2	-	X		
<b>Truck PLUS Evolution</b>												
680 89	180	1000	4	1	B03	D5	FL	HL2	X	-		
<b>Truck PLUS Evolution</b>												
690 13	190	1050	3	1	B00	D5	SL/IV	HL2	X	-		



Catalogue code	Ah 20h	A EN								Heavy Duty	Super Heavy Duty	
<b>Truck PLUS Evolution</b>												
690 14	190	1050	3	1	B00	D5	FL	HL2	X	-		
<b>Truck SHD</b>												
690 32	190	1050	3	1	B00	D5	SL/IV	HL2	-	X		
<b>Truck SHD</b>												
690 34	190	1050	3	1	B00	D5	FL	HL2	-	X		
<b>Truck PLUS Evolution</b>												
700 13	200	1100	3	1	B00	D5	SL/IV	HL2	X	-		
<b>Truck PLUS Evolution</b>												
700 14	200	1100	3	1	B00	D5	FL	HL2	X	-		
<b>Truck PLUS Evolution</b>												
700 15	200	1100	3	1	B00	D6	FL	HL2	X	-		
<b>Truck SHD</b>												
710 27	210	1050	3	1	B00	D6	FL	HL2	-	X		
<b>Truck SHD</b>												
730 11	230	1200	3	1	B00	D6	FL	HL2	-	X		
<b>Truck SHD</b>												
730 29	230	1200	4	1	B00	D6	FL	HL2	-	X		

# Special / Military

Catalogue code

V

Ah  
20h

A  
EN

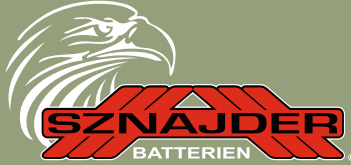
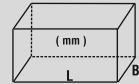

## THE POWER COMPANY-SINCE 1925

### Special / Military

080 01	6	80	600	0	1	B00	M2	FL	-
--------	---	----	-----	---	---	-----	----	----	---

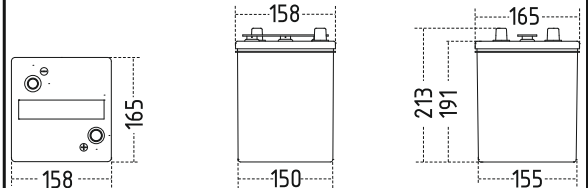

### Special / Military

112 84	6	112	720	0	1	B01	M4	FL	-
--------	---	-----	-----	---	---	-----	----	----	---

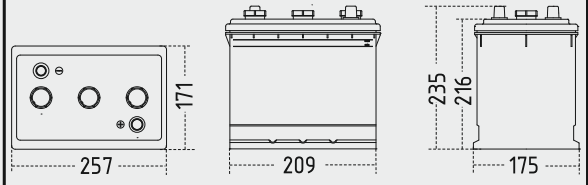

### Special / Military

140 84	6	140	900	0	1	B01	M4	FL	-
--------	---	-----	-----	---	---	-----	----	----	---

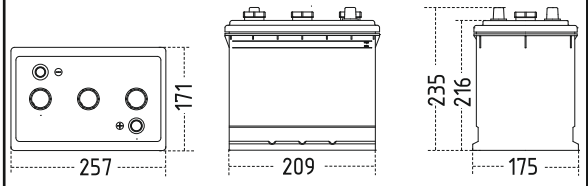

### Special / Military

165 38	6	165	900	0	1	B01	M5	FL	HL2
--------	---	-----	-----	---	---	-----	----	----	-----

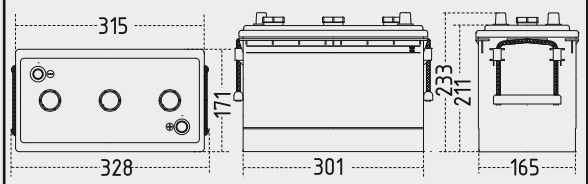

### Special / Military

200 56	6	200	1150	0	1x2	B01	M6	FL	HL2
--------	---	-----	------	---	-----	-----	----	----	-----

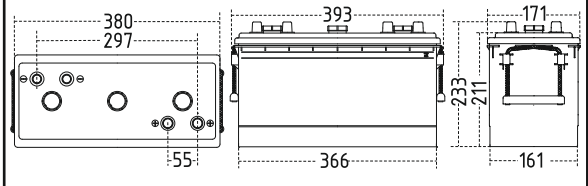

### Special / Military

200 58	6	200	1150	0	RA	B01	M6 RA	FL	HL2
--------	---	-----	------	---	----	-----	-------	----	-----

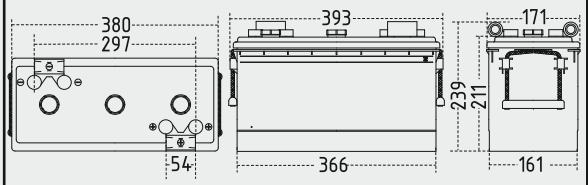

### Special / Military

225 56	6	225	1250	0	1x2	B01	M6	FL	HL2
--------	---	-----	------	---	-----	-----	----	----	-----

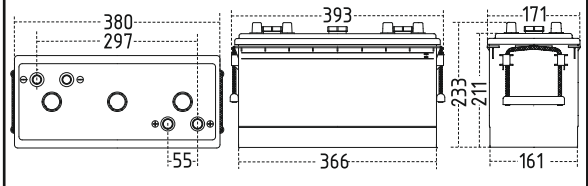

### Special / Military

260 08	6	225	1250	0	1	B01	M8	FL	IHL
--------	---	-----	------	---	---	-----	----	----	-----

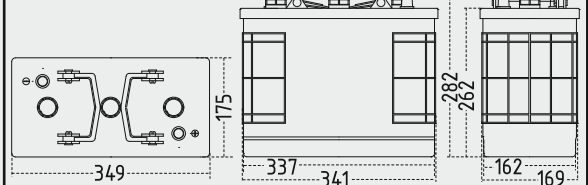

Catalogue code	V	Ah 20h	A EN								
<i>Special / Military</i>											
610 23	12	110	900	2	1	B00	D7	FL	HL2		
<i>Special / Military</i>											
625 23	12	125	1000	2	1	B00	D7	FL	HL2		
<i>Special / Military</i>											
635 39	12	135	900	3	1	B03	F15	FL	HL2		
<i>Special / Military</i>											
645 39	12	145	900	0	1	B00	F21	FL	HL2		
<i>Special / Military</i>											
665 67	12	165	850	0	1	B00	D67	FL	HL2		

## Farmer - 6V

Catalogue code	Ah 20h	A EN									
<b>Farmer (6V)</b>											
165 17	165	900	0	1	B01	H1	FL	IHL	X	-	
<b>Farmer (6V)</b>											
195 17	195	1100	0	1	B01	H1	FL	IHL	X	-	
<b>Farmer (6V)</b>											
215 17	215	1150	0	1	B01	H1	FL	IHL	X	-	

# Marine

Catalogue code	V	Ah 5h/20h/100h	A EN							
----------------	---	-------------------	---------	--	--	--	--	--	--	--

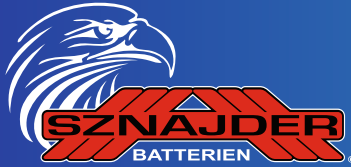
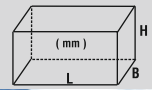

THE POWER COMPANY-SINCE 1925



## Marine

857 50	12	60/75/90	-	0	1	B13	L3	SL/IV	IHL
--------	----	----------	---	---	---	-----	----	-------	-----

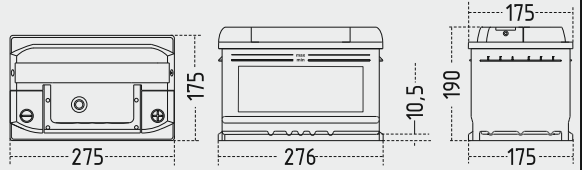

## Marine

857 51	12	60/75/90	-	1	1	B13	L3	SL/IV	IHL
--------	----	----------	---	---	---	-----	----	-------	-----

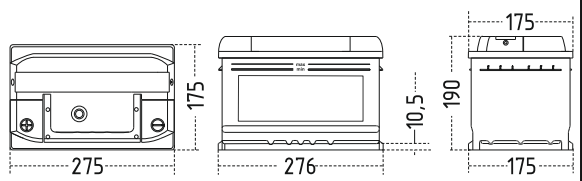

## Marine

860 00	12	75/100/110	-	0	1	B13	L5	SL/IV	IHL
--------	----	------------	---	---	---	-----	----	-------	-----

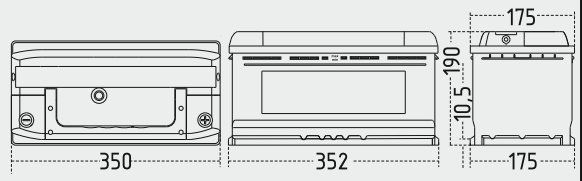

# Energy Plus

Catalogue code	V	Ah 5h/20h/100h	A EN							
----------------	---	-------------------	---------	--	--	--	--	--	--	--

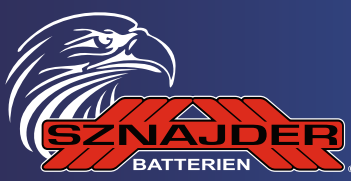
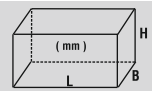

THE POWER COMPANY-SINCE 1925



## Energy Plus

956 07	12	50/60/70	480	0	1	B13	L2	SL/IV	IHL
--------	----	----------	-----	---	---	-----	----	-------	-----

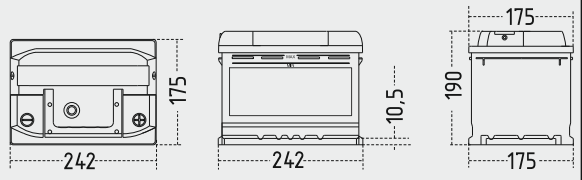

## Energy Plus

958 07	12	60/80/90	600	0	1	B13	L3	SL/IV	IHL
--------	----	----------	-----	---	---	-----	----	-------	-----

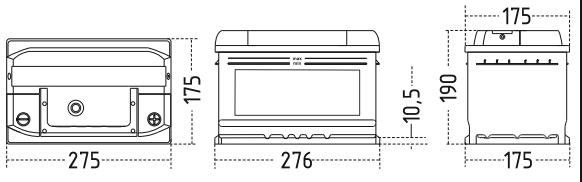

## Energy Plus

960 07	12	75/100/110	720	0	1	B13	L5	SL/IV	IHL
--------	----	------------	-----	---	---	-----	----	-------	-----

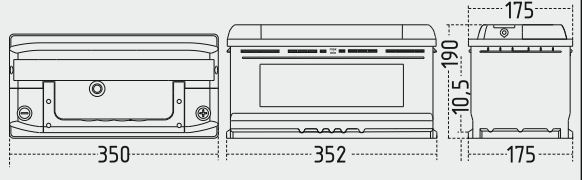

Catalogue code	V	Ah 5h/20h/100h	A EN								
<b>Energy Plus</b>											
961 07	12	82/110/120	680	0	1	B01	D2	SL/IV	IHL		
<b>Energy Plus</b>											
964 00	12	115/140/150	640	3	1	B00	D4	FL	HL2		
<b>Energy Plus</b>											
967 50	12	135/175/185	900	3	1	B00	D5	SL/IV	HL2		
<b>Energy Plus</b>											
968 14	12	145/185/195	1000	3	1	B00	D5	FL	HL2		
<b>Energy Plus</b>											
968 50	12	145/185/195	1000	3	1	B00	D5	SL/IV	HL2		



0/6V

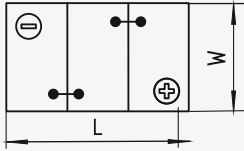

0/12V

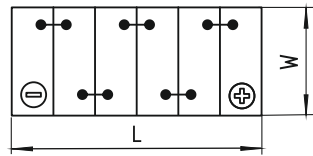

1/12V

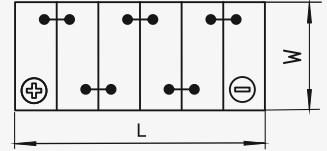

2/12V

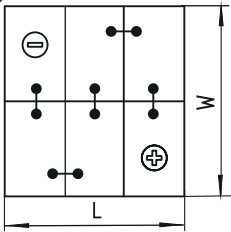

3/12V

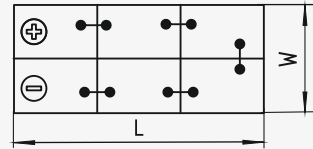

4/12V

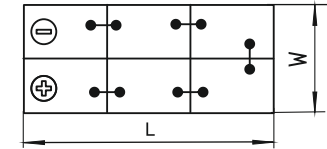

1

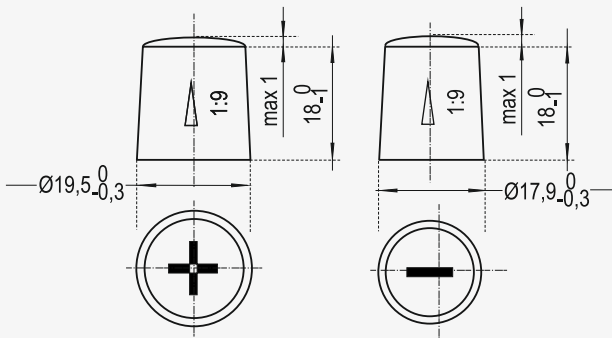

3

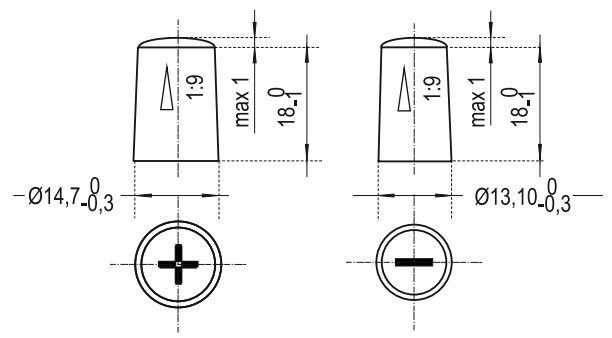

3+A

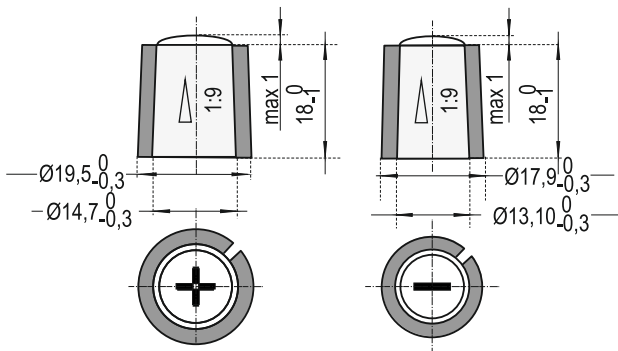

ERA

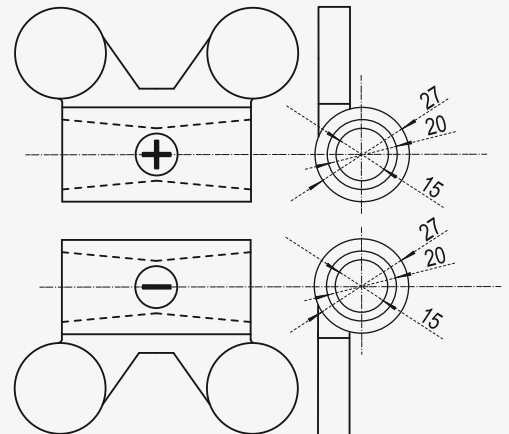

19

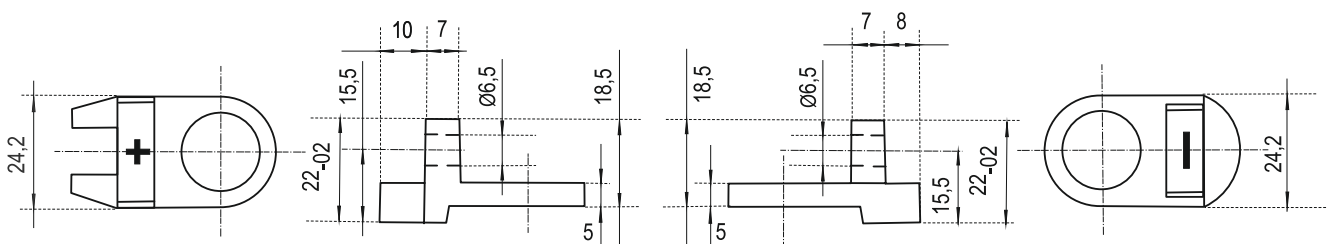



# Typ mocowania / Base hold-downs

## B00

FRONT



SIDE

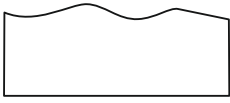

## B01

FRONT

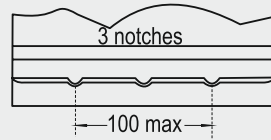

SIDE

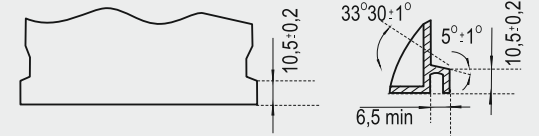

## Ba1

FRONT

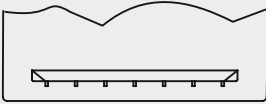

SIDE

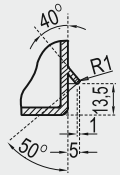
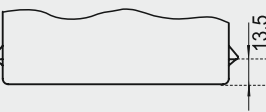

## B03

FRONT

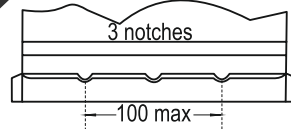

SIDE

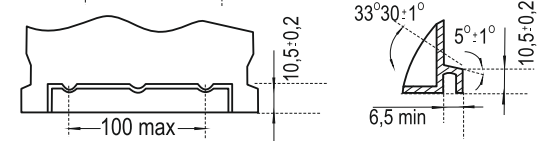

## B03+A

FRONT

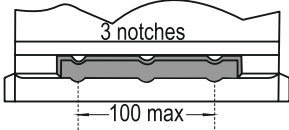

SIDE

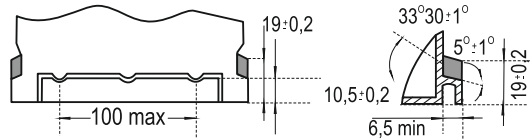

## B05

FRONT

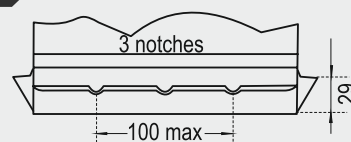

SIDE

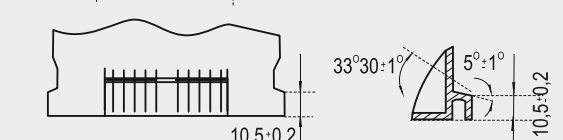

## B13

FRONT

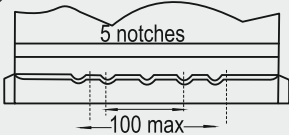

SIDE

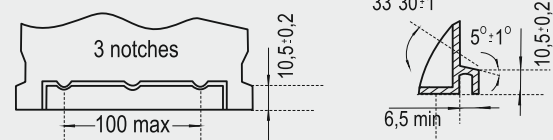

## B13+A

FRONT

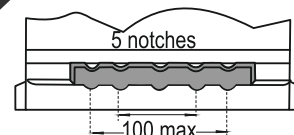

SIDE

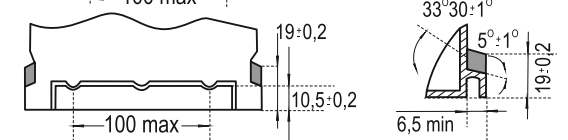

# Uchwyt / Handle

## HL1

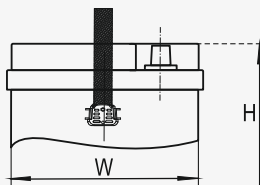

## HL2

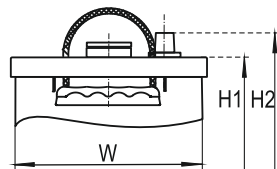

## IHL

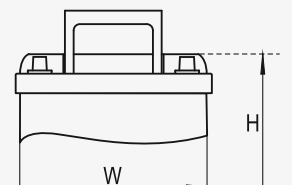

# Wieczko / Cover

## BL

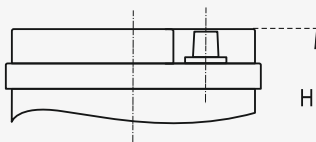

## SL

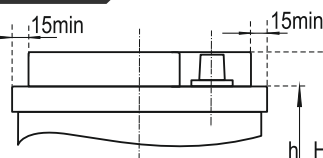

## FL

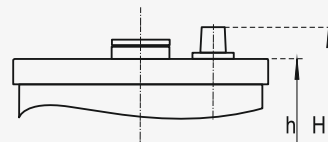

## IV

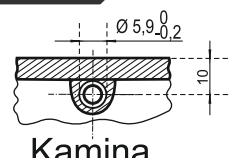

Kamina